

SERIES POE-A AND POE-B

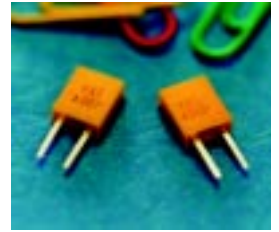

FEATURES

- SMALL AND LIGHT
- HIGH DURABILITY
- EXCELLENT TEMPERATURE STABILITY
- LOW COST

SPECIFICATIONS

FREQUENCY RANGE	190 - 249 khz	250 - 374 khz	375 - 429 khz	430 - 509 khz	510 - 649 khz	650 - 767 khz	768 - 1250kHz
SERIES	POE-A	POE-A	POE-B	POE-B	POE-B	POE-A	POE-B
DIMENSIONS	FIGURE 1	FIGURE 2	FIGURE 3	FIGURE 4	FIGURE 5	FIGURE 6	FIGURE 7
EXTERNAL CAPACITANCE	C1	330pF	220pF	120pF	100pF	100pF	100pF
	C2	470pF	470pF	470pF	100pF	100pF	100pF
FREQUENCY TOLERANCE AT 25° C	±0.5%	±0.5%	±0.3%	±0.3%	±0.3%		
FREQUENCY STABILITY OVER TEMPERATURE RANGE	±1 kHz	±1 kHz	±2 kHz	±2 kHz	±2 kHz	±2 kHz	±5 kHz
OPERATING TEMPERATURE RANGE	-20°C TO 80°C						
FREQUENCY AGING (10 YEARS)	±0.5%	±0.5%	±0.5%	±0.5%	±0.5%	±0.5%	±0.5%

OUTLINE DRAWINGS

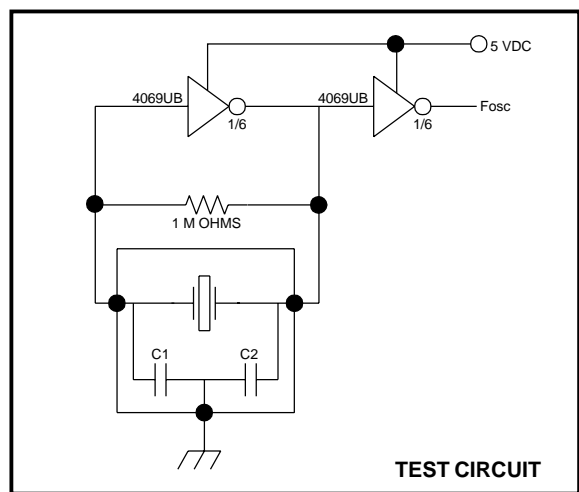
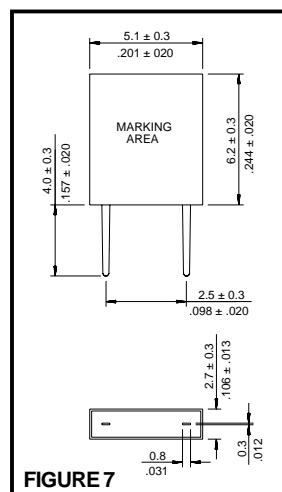
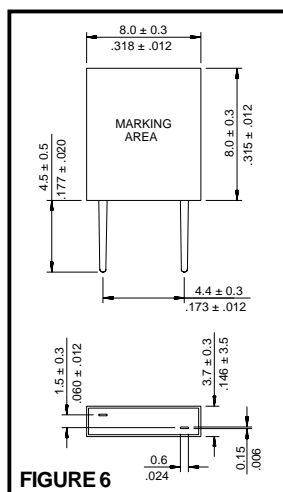
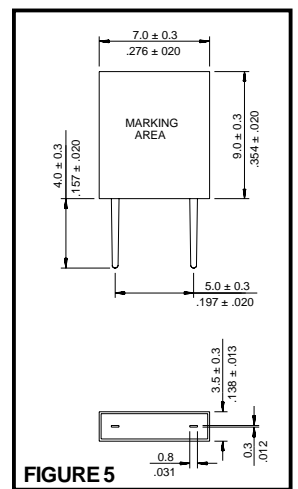
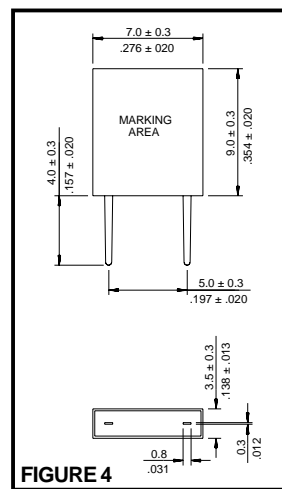
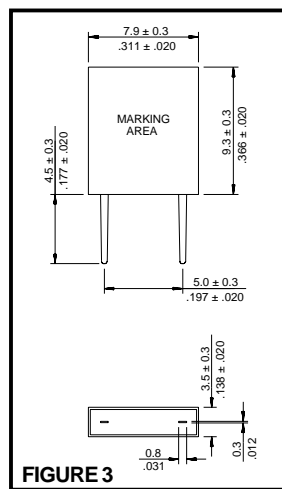
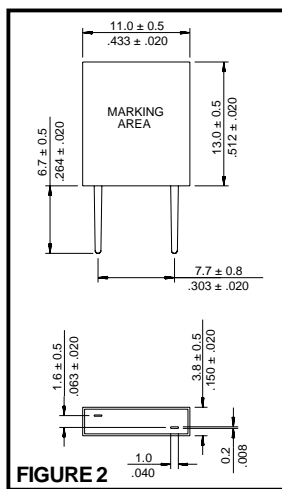
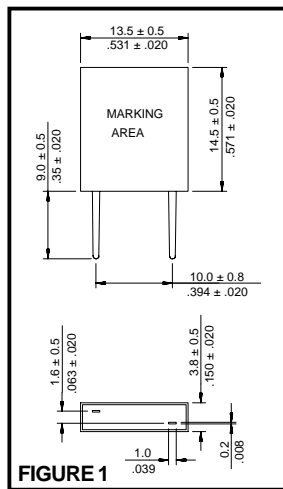

PART NUMBERING SYSTEM

SERIES	-	FREQUENCY
POE-A		IN kHz
POE-B		

TERMINAL PIN LOCATION

POE-A	BIAS/OFFSET
POE-B	EQUAL LINE

EXAMPLE: POE-A-400 AND POE-B-544