

Series SMRN

- Features
 - Surface Mount Packaging
 - Wide Frequency Range
 - Internal or external loading capacitance
- Specifications

SERIES	SMRN-A	SMRN-B	SMRN-A1	SMRN-B1
FREQUENCY RANGE	16.000 ~ 48.000 MHz		3.580 ~ 48.000 MHz	
FREQUENCY TOLERANCE AT 25°C	±0.5 % MAX			
FREQUENCY STABILITY OVER -20°C TO +80°C	±0.3 % MAX	±0.3 % MAX	±0.5 % MAX	±0.5 % MAX
EQUIVALENT SERIES RESISTANCE (ESR)	100 OHMS MAX	100 OHMS MAX	100 OHMS MAX	100 OHMS MAX
CAPACITANCE	EXTERNAL	INTERNAL	EXTERNAL	INTERNAL
AGING AT 10 YEARS	±0.3 % MAX			

NOTE: CERTAIN FREQUENCIES MAY NOT BE AVAILABLE, CONSULT RAMI FOR INFORMATION.

Outline Drawings

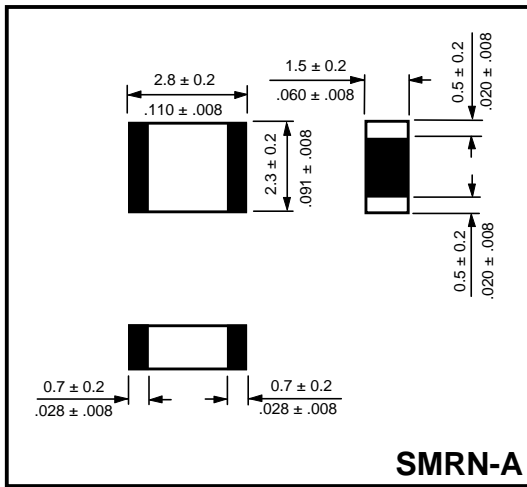

LOWER HEIGHTS AVAILABLE

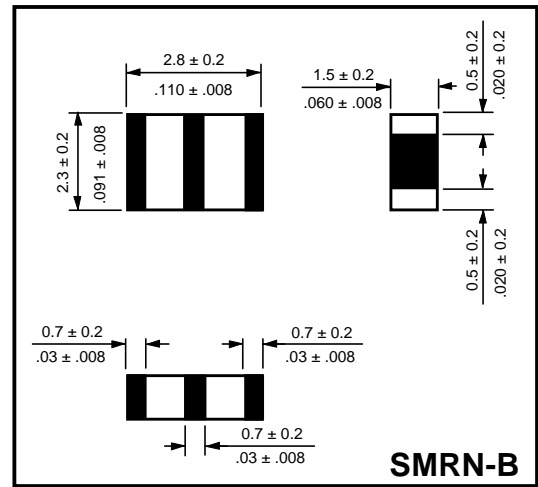

SMRN-B

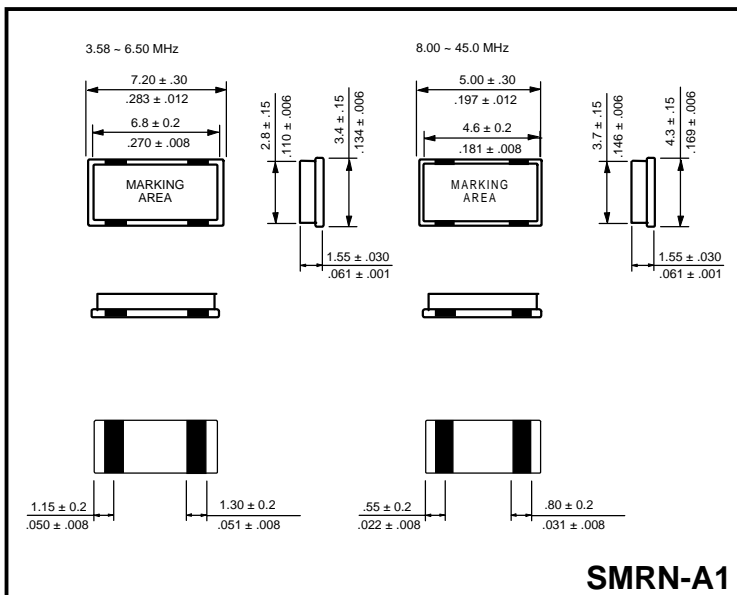

SMRN-A1

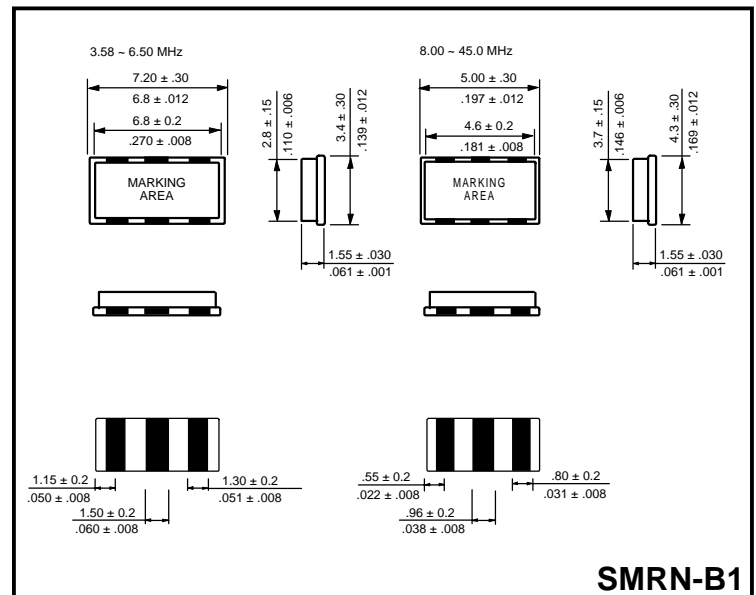

SMRN-B1

Series SMRN

● Test Circuits

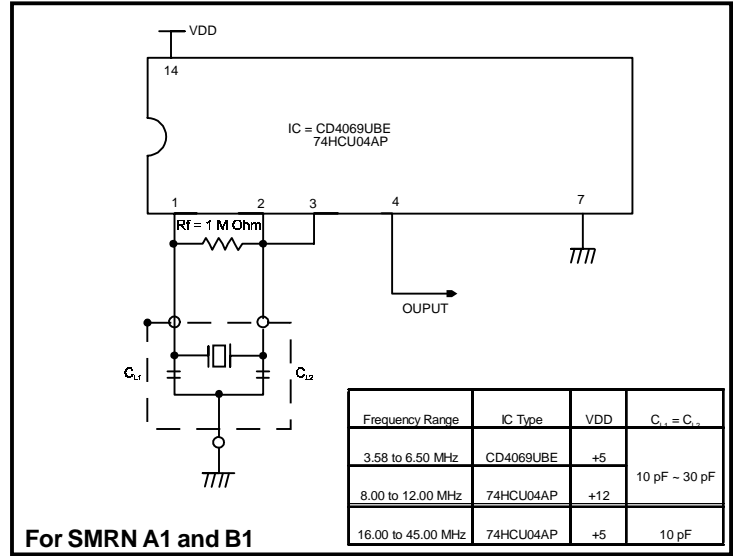
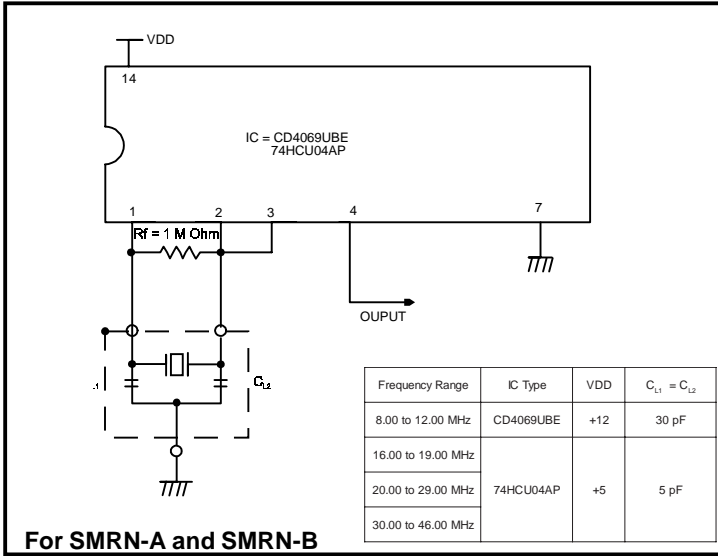

● Carrier Tape Dimensions

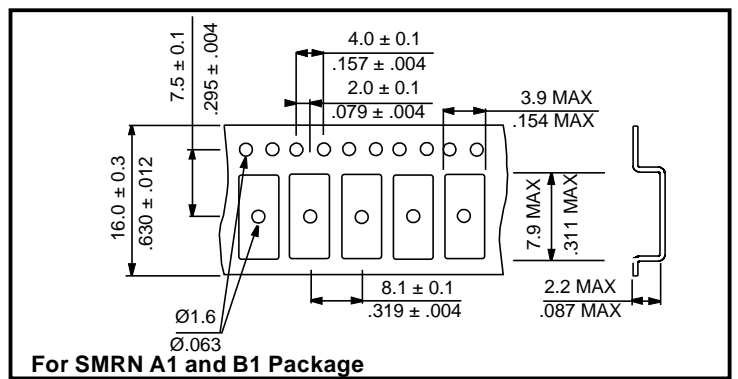
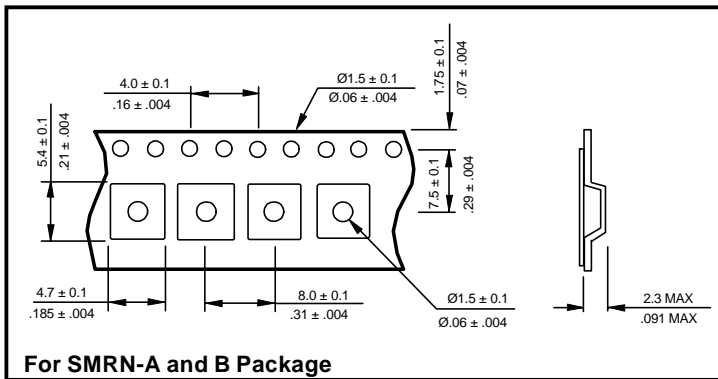

● Part Numbering System

Series	Frequency	Configuration	Tape and Reel
SMRN	in MHz	A B B1 A1	TR

Example: SMRN-20.000-A-TR
SMRN-3.58-B1-TR